

92 M - 6250 BHP - DP 2 - MPSV

## Vessel Specifications



# Vessel Specifications

## Registration

Year built	2001
Port of registry / flag	Marshall Islands
Design	
Class	DNV-GL +1A1, DK(+), DYNPOS (AUTR), EO, HELDK (H,S), HL (2.8), OILREC SF Methanol certification to be re-validated by Class prior use

## Dimensions

Length overall	92.40 m
Length overall (with helideck)	97.80 m
Breadth moulded	18.80 m
Breadth moulded (with helideck)	23.00 m
Depth main deck	7.60 m
Max draft	6.20 m
Depth to 1 <sup>st</sup> deck	7.20 m
Depth to 2 <sup>nd</sup> deck	5.00 m
Deadweight at summer draft	3835 t
Registered tonnage	GRT 3992 t / NRT 1306 t

## Machinery

Propulsion	6250 bhp - 2 x 2300 kw @ 195 rpm, ABB Azipods 5 pull
Main engines	4 x Bergen engines KRGB-9, 1990 kw each @ 900 rpm
Bow thrusters	2 x Ulstein 250 TV tunnel thrusters, 883 kw each 1 x Ulstein retractable Azimuth thruster, 883 kw
Main generator	4 x AMG 630 M8, 690 V, 2363 kVA, 60Hz
Emergency generator	2 x Scania DI 14, 350 kw @ 1800 rpm 1 x Stamford Gen.HGM 534 C1, 690 v, 438 kVA
Fresh water maker	2 x 25 m <sup>3</sup> / day, seawater desalination with reverse osmosis
Oily water separator	1 m <sup>3</sup> / hr, Heli-Sep 1000
Sewage treatment plant	10.5 m <sup>3</sup> / day, AquaMar GmbH
Roll damping system	Passive stabilizing system consisting of 3 tanks

<b>DP equipment - reference systems</b>	DP Class II Kongsberg K-Pos DP21 - 1 x KM DPS 100 (in repair) - 1 x KM DPS 132 - 1 x DGPS+GLONASS - Fugro 9205 GNSS - 1 x Fanbeam - MDL MK 4, Range up to 1000m - HPR - Sonardyne USBL Syst V6
Joystick control system	Kongsberg C-joy type, integrated into thruster control and DP system Available from center aft console or via wing connections

<b>Helideck equipment</b>	Super Puma, diameter: 20 m, weight: 9.3 t Aluminium construction Heli-deck monitoring system: SEC-REC HMS Motion system SMC 1MU108
---------------------------	---

## Off-shore sub-sea crane

Model	1 x TTS Norlift - GPCFO 2500 - 10040
Lifting capacity	1 fall - SWL 50 t @ 6-9 m / 1 fall - SWL 18 t @ 6-40 m 2 fall - SWL 100 t @ 6-09 m / 2 fall - SWL 10 t @ 6-38.5 m
Maximum water depth	Single fall (50 t) - 1500 m Double fall (100 t) - 750 m
Hoisting speed with working radius	Single fall light load 70 m / min, full load 25 m / min Double fall light load 35 m / min, full load 12.5 m / min
Anti-heeling system	2 x PG - Bornemann VHC 180, 2-85, Capacity: 250 m <sup>3</sup> / hr @ 2 bar
Personnel lift	TTS 100 t, crane only 4% winch capacity (max 2 t including equipment)

# Vessel Specifications

## Deck machinery and equipment

Air supply	5 outlets for working air on deck Air capacity: approx 125 m <sup>3</sup> / hr @ 8 bar
Electrical power	Deck supply: - 3PCS CEAG 1 - phase - 16A / 230V (Eex - ed) - 1PCS CEAG 3 - phase - 32A/230V (Eex - ed) ROV switchboard: 2 pcs circuit, 650 kVA each, 450 v, 60Hz
Stores crane (portside)	1 x HMC Knuckle jib 1077, SWL 2 t @ 12 m
ROV crane (starboardside)	1 x HMC Knuckle jib 1610 SWL 20 t @ 9 m SWL 15 t @ 12 m
Tugger winches	2 x 10 t @ 15 m / min, make: Brattvaag AKM 4110 SWL 10 t
Anchor windlass	1 x 45 bar pressure for 46 mm (dia) chain, make: Rolls Royce
Capstan	2 x Br. Rogne HP
Anchors	Stockless Bower anchors, 2 x 3300 kg
Anchor chains	Stud-link chain cable, 495 M total (NV, K3, 46 mm)

## Performance

Max speed	11 knots
Service speed	9.5 knots
Consumption	Maximum speed - 20 m <sup>3</sup> / day Service speed - 15 m <sup>3</sup> / day DP operations - (calm weather) 7 m <sup>3</sup> / day At port - 2.5 m <sup>3</sup> / day on main generator or 1 m <sup>3</sup> / day on harbour

## Capacities 100%

Fuel oil	1212 m <sup>3</sup>
Fresh water	985 m <sup>3</sup>
Water ballast	1840 m <sup>3</sup>
Drill water	1639 m <sup>3</sup>
Liquid mud	669 m <sup>3</sup>
Brine	863 m <sup>3</sup>
Base oil @ 90%	203 m <sup>3</sup>
Slop	337 m <sup>3</sup>
Oil recovery	1012 m <sup>3</sup>
Methanol @ 90%	155 m <sup>3</sup>
Freezer, cooler and dry provisions	Freezer 18 m <sup>3</sup> , Cooler 25 m <sup>3</sup> and Dry Store 20 m <sup>3</sup>
Clear deck area	880 m <sup>2</sup> (55 m x 16 m)
Deck cargo capacity	2600 t @ 10 t / m <sup>2</sup>

Oil recovery equipment - The vessel is arranged for oil recovery according to NOFO 2000 with min. 1000 m<sup>3</sup> capacity

## Transfer rates

Fuel oil / ORO	1 x PG - Bornemann VHC 180 - 74, 0 - 250 m <sup>3</sup> / hr @ 9 bar
Fresh water	1 x PG - Bornemann VHC 180 - 74, 0 - 250 m <sup>3</sup> / hr @ 9 bar
Water ballast / drill water	1 x PG - Bornemann VHC 180, 2 - 65, 0 - 250 m <sup>3</sup> / hr @ 9 bar
Brine	2 x PG - Bornemann VHC 180, 2, 100 m <sup>3</sup> / hr @ 24 bar
Liquid mud	2 x PG - Seepex 70 - 18BN, 75 m <sup>3</sup> / hr @ 24 bar
Base oil	1 x PG - Bornemann VHC 147 - 73, 150 m <sup>3</sup> / hr @ 9 bar
Slop	1 x PG - Seepex 70 - 18BN, 75 m <sup>3</sup> / hr @ 24 bar
Methanol	2 x PG - Seepex 50 - 250 AT, 50 m <sup>3</sup> / h, 90 mlc
Pipeline connections	5" type WECO for fresh water, ballast / drill water, fuel oil / ORO, brine, mud, base oil 4" type WECO for slop 4" pipe flange connection, bore 180 mm
Methanol	

# Vessel Specifications

## Navigation and communication

Inmarsat C	Felcom 12
GMDSS	A1 + A2 + A3
VSAT system	TAC - 92 + CDM 570L + VE 4204 - FXS
Radars	1 x FR 2115, 1 x FR 2835S
GPS navigator	1 x Furuno GP-80
Autopilot	1 x Anschutz Pilot Star D
Navtex receiver	1 x Furuno NX - 500
Gyro compass	3 x Anschutz Digital Gyro STD 22
Magnetic compass	1 x Bergen Navtic
MF / HF SSB DSC	Furuno DSC - 60
Echo sounder	Furuno FE - 700
VHF radio telephone	FURUNO FM 8700 / FURUNO FM 8800 (instead of FM 800, FM 2500)GMDSS
handheld radio	3 x Tron VHF
SART	2 x Jotron SART
Doppler speed log	1 x Furuno DS - 80
EPIRB	McMurdo + Jotron Tron 45 S / SX
Wind indicator	2 x Obsermet OMC 139
Barometer	1 x Hanseatic

---

## Firefighting and life-saving equipment

Firefighting	As per the class notification and SOLAS requirements
Rescue boat	1 x Springer MP 800, 10 persons, max 750 kg
Life rafts	2 x 73 persons, make: Norsafe 18 x 25 persons, make: Viking
Safety equipment	As per the LSA
Accommodation (144 bunks)	11 x 1 man cabins = 11 berths 17 x 2 man cabins = 34 berths 1 x 3 man cabins = 03 berths 21 x 4 man cabins = 84 berths 2 x 6 man cabins = 12 berths 1 x hospital

All cabins are air conditioned and well equipped with WC and shower. The vessel has recreation area with TV, video, smokers lounge, gymnasium, etc.

Last revision August 2017

# Tank Capacities

Tanks	SG m <sup>3</sup>	Fuel oil 0.850	Pot water 1.000	Drill water 1.000	Ballast water 1.025	Liquid mud 2.800	Brine 2.500	Base oil 0.830	Glycol 1.120	Dry bulk 2.40	Oil recovery 1.00
FOREPEAK TK	125.30			125.30	128.43						
DB/WING TK 1 PS	125.60		125.60								
DB/WING TK 1 SB	120.50		120.50								
DB/WING TK 2 PS	120.40		120.40								
DB/WING TK 2 SB	112.30		112.30								
DB/WING TK 3 PS	157.00	133.45									
DB/WING TK 3 SB	112.10	95.28									
SLUDGE TANK	13.10										
OILY WATER TK	13.10										
OVERFLOW TK	15.70										
DIRTY OIL TK	15.70										
DB TK 4 PS	60.20	51.17									
DB TK 4 SB	60.20	51.17									
DB/WING TK 5 PS	199.10	169.23									
DB/WING TK 5 SB	199.60	169.66									
OVERFLOW TK AFT	41.70										
DB/WING TK 7 PS	107.70	91.54									
DB/WING TK 7 SB	107.70	91.54									
SEWAGE TK	14.20										
HOT WATER	13.40										
SERVICE TK SB	29.30	24.90									
FOAM TK	18.70										
SERVICE TK SB	29.30	24.90									
WING TK 4 PS	112.80							93.62			
WING TK 4 SB	112.80							93.62			
TANK 6 PS	57.10			57.10	58.52		142.75				
TANK 6 SB	57.10			57.10	58.52		142.75				
WING TK 8 PS	95.20			95.20	97.58		238.00				
WING TANK 8 SB	95.20			95.20	97.58		238.00				
DB/WING TK 9 PS	60.40	51.34									60.40
DB/WING TK 9 SB	60.40	51.34									60.40
AFT PEAK PS	246.50		246.50								
AFT PEAK SB	246.50		246.50								
TK 7 PS	83.80										
TK 7 SB	83.80										
C/D	201.40				206.43						
STAB TK 1	240.60			240.60	246.61		601.50				240.60
STAB TK 2	337.40			337.40	345.83						337.40
STAB TK 3	313.30			313.30	321.13						313.30
HO TK	4.50										
LO THR TK	4.50										
AUX ENG LO TK	4.50										
GEAR OIL TK	4.50										
LO STORE TK MAIN ENG	17.90										
SETTLING TK	30.10	25.58									
SERVICE TK EM GEN SET	2.70	2.29									
TK 2 PS	79.30			79.30	81.28	222.04	198.25				
TK 2 SB	79.30			79.30	81.28	222.04	198.25				
TK 3 PS	79.30					222.04					
TK 3 SB	79.30					222.04					
TK 4 PS	88.10					246.68					
TK 4 SB	88.10					246.68					
TK 5 PS	88.10					246.68					
TK 5 SB	88.10					246.68					
VOID TK	14.20										
SERVICE TK INCINERATOR	0.20	0.17									
FW DRAIN TK	13.80		13.80								
TK 1 PS	79.70			79.70	81.69		199.25				
TK 1 SB	79.70			79.70	81.69		199.25				
C/D	29.40										
C/D	9.00										
C/D	9.00										
C/D	1.40										
C/D	16.00										
DRY TK FWD	7.90										
<b>Weight in tonnes</b>		<b>1033.60</b>	<b>985.60</b>	<b>1639.20</b>	<b>1886.61</b>	<b>1874.88</b>	<b>2158.00</b>	<b>187.25</b>			<b>1012.10</b>
<b>Volume in m<sup>3</sup></b>		<b>1216.00</b>	<b>985.60</b>	<b>1639.20</b>	<b>1840.60</b>	<b>669.60</b>	<b>863.20</b>	<b>225.60</b>			<b>1012.10</b>

# GA Specifications

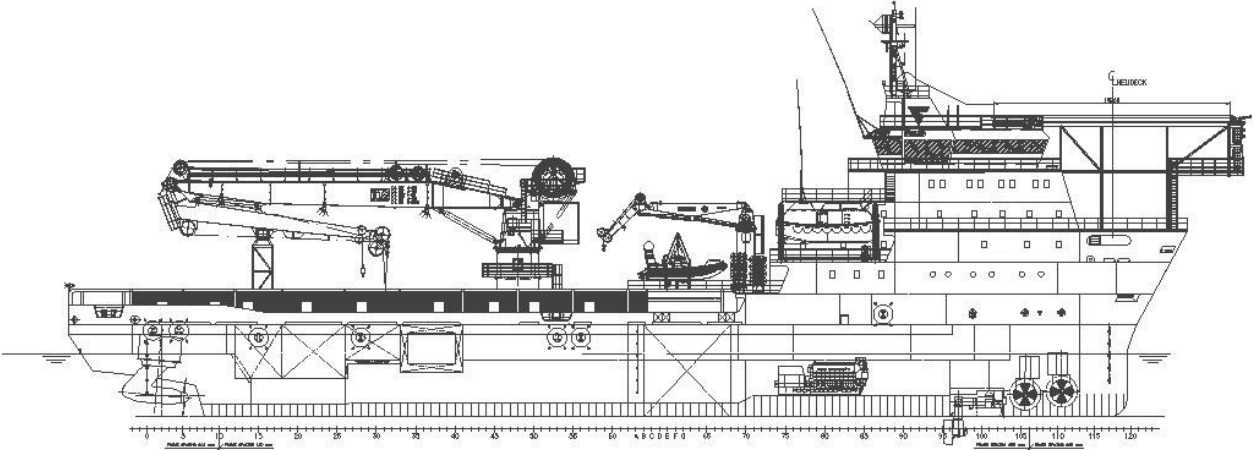

Profile

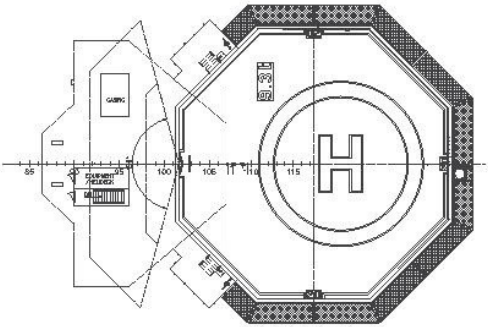

Heli deck

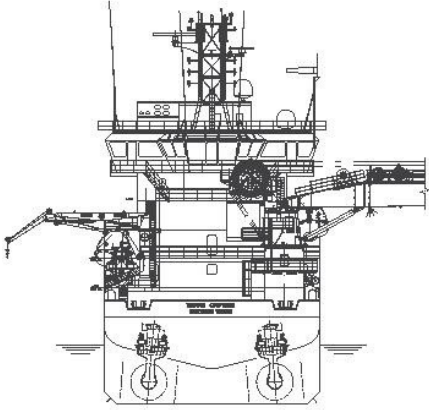

Seen from AFT

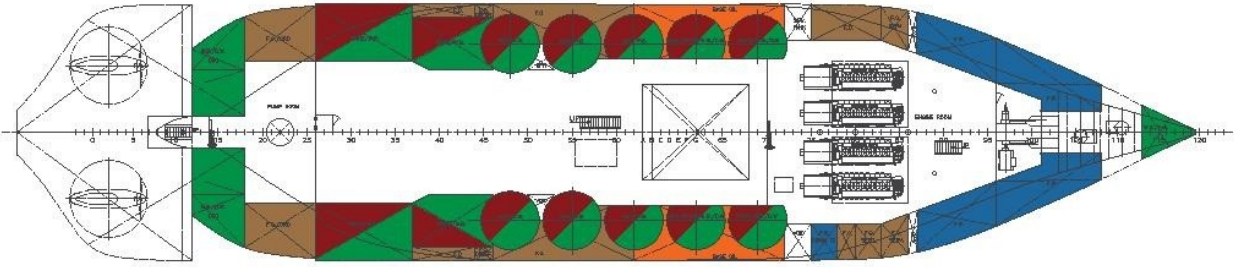

Tank top

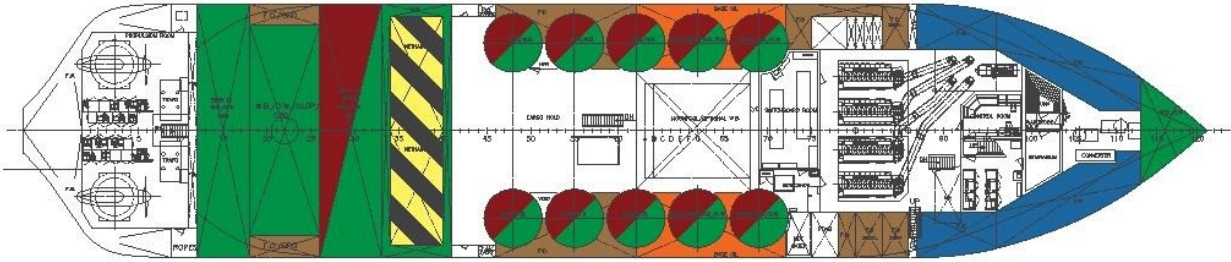

2<sup>nd</sup> deck

# GA Specifications

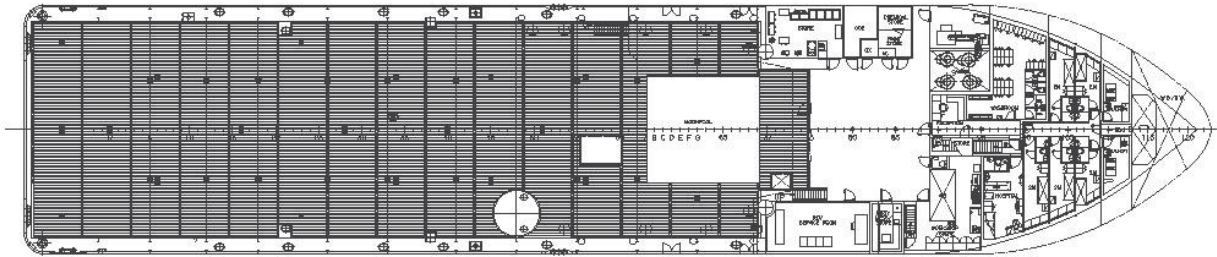

Main deck

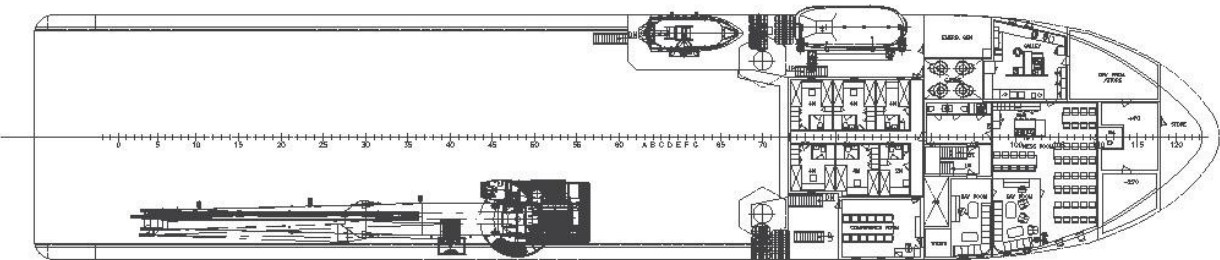

A-deck

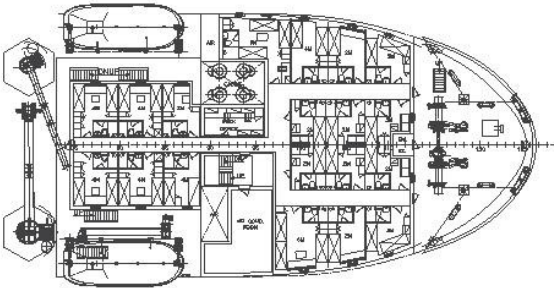

B-deck

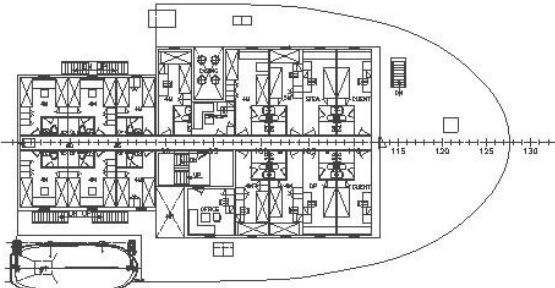

C-deck

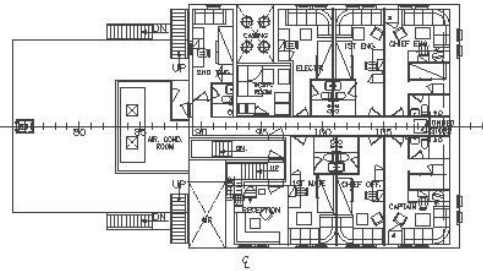

D-deck

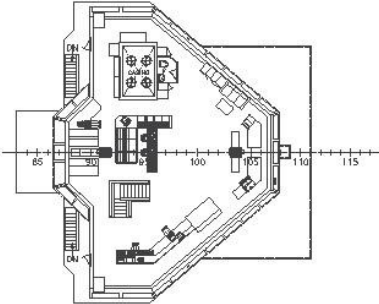

Bridge deck

# DP Capability Plot

## DP capability envelope for case 1

VARIABLE WIND AND WAVES  
Limiting 1 minute mean wind speed in knots  
at 10 m above sea level

ERN = 97  
ERN are subject to DNV approval

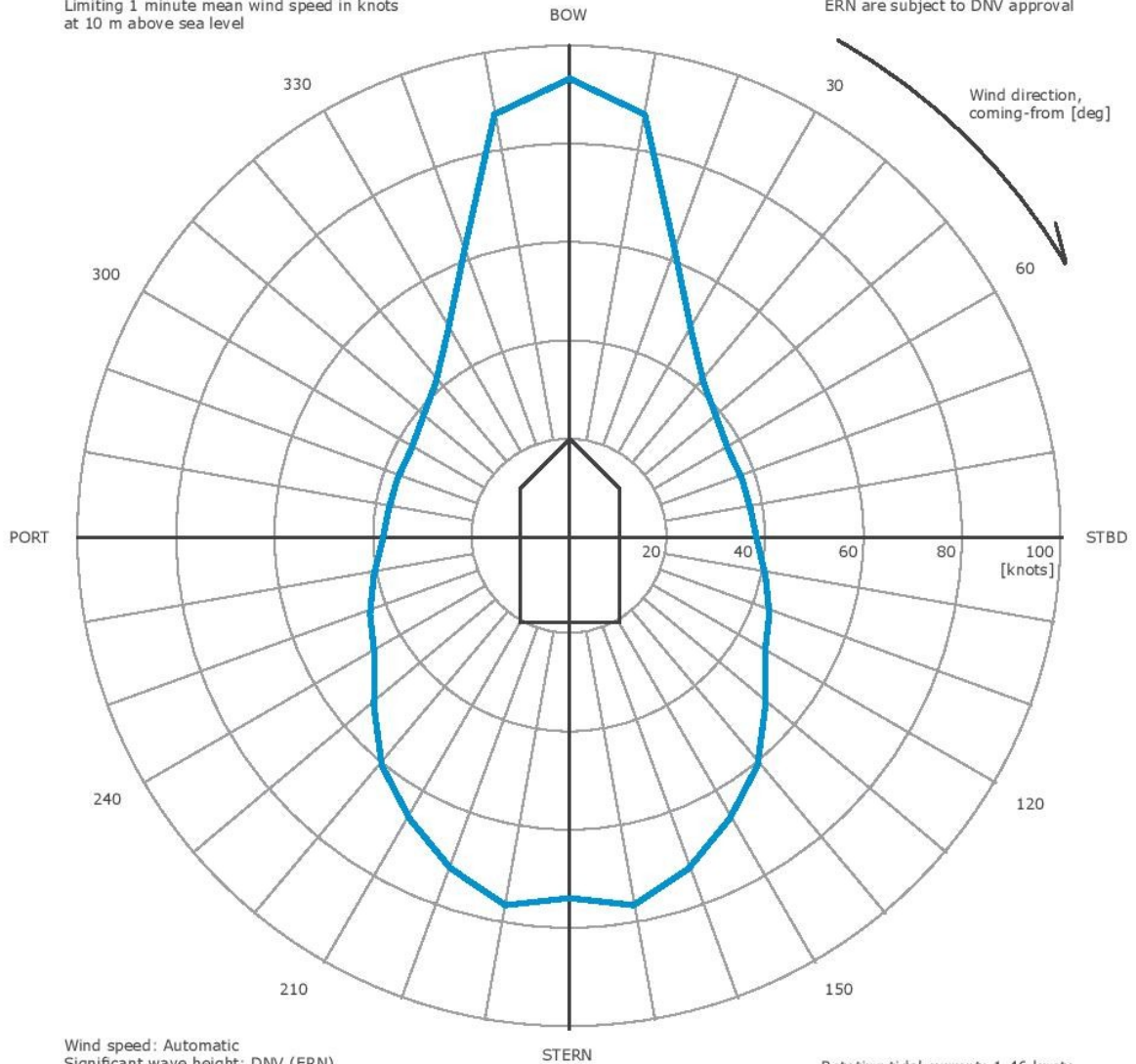

Wind speed: Automatic  
Significant wave height: DNV (ERN)  
Mean zero up-crossing period: DNV (ERN)

Rotating tidal current: 1.46 knots  
Rotating wind induced current: 0.000\*Uwi knots



### KONGSBERG

Case number : 1  
Case description : Optimum use of all thrusters  
Thrusters active : T1-T5  
Rudders active :

Input file reference : Foot\_2543C.scp  
Last modified : 2011-02-21 14.55 (v. 2.8.0)

Length overall : 97.0 m  
Length between perpendiculars : 80.8 m  
Breadth : 18.8 m  
Draught : 6.2 m  
Displacement : 6800.0 t (Cb = 0.70)  
Longitudinal radius of inertia : 20.2 m (= 0.25 \* Lpp)  
Pos. of origin ahead of Lpp/2 (Xo): 0.0 m  
Wind load coefficients : Calculated (Blendermann)  
Current load coefficients : Calculated (Strip-theory)  
Wave-drift load coefficients : Database (Scaled by breadth / length)

Tidal current direction offset : 0.0 deg  
Wave direction offset : 0.0 deg  
Wave spectrum type : JONSWAP (gamma = 3.30)  
Wind spectrum type : NPD  
Current - wave-drift interaction : OFF  
Load dynamics allowance : 1.0 \* STD of thrust demand  
Additional surge force : 0.0 tf  
Additional sway force : 0.0 tf  
Additional yawing moment : 0.0 tf.m  
Additional force direction : Fixed  
Density of salt water : 1026.0 kg / m<sup>3</sup>  
Density of air : 1.226 kg / m<sup>3</sup> (15 °C)

Power limitations : OFF  
Thrust loss calculation : ON

#	Thruster	X [m]	Y [m]	F+ [tf]	F- [tf]	Max [%]	Pe [kW]	Rudder
1	TUNNEL	33.8	0.0	10.8	-10.8	100	883	
2	TUNNEL	30.8	0.0	10.8	-10.8	100	883	
3	AZIMUTH	25.3	0.0	14.4	-8.4	100	883	
4	AZIMUTH	-40.4	5.5	28.3	0.0	100	1600	
5	AZIMUTH	-40.4	-5.5	28.3	0.0	100	1600	

All the details are believed to be correct but not guaranteed  
and owners reserve the right to amend them.