

CUBIERTA PRINCIPAL

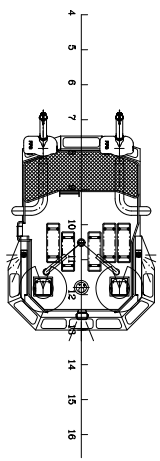

TECHO PUENTE GOBIERNO

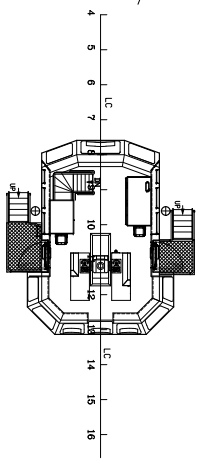

PUENTE GOBIERNO

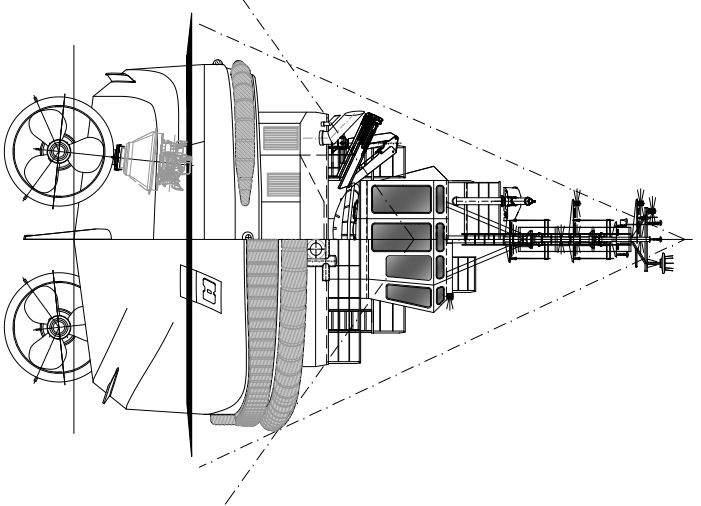

CUBIERTA BOTE

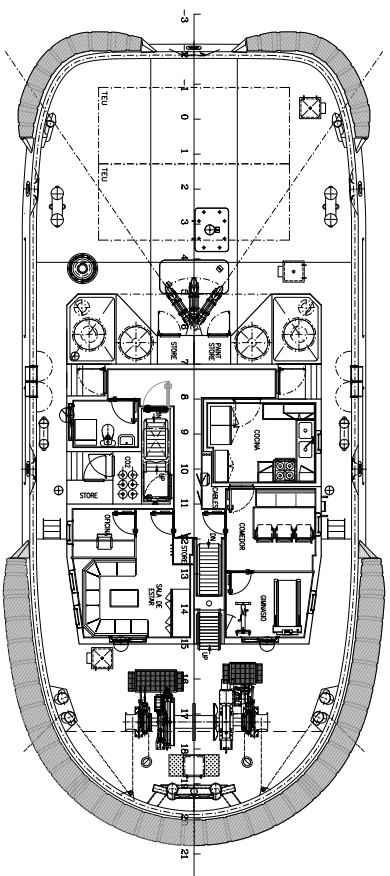

SALA DE MAQUINAS

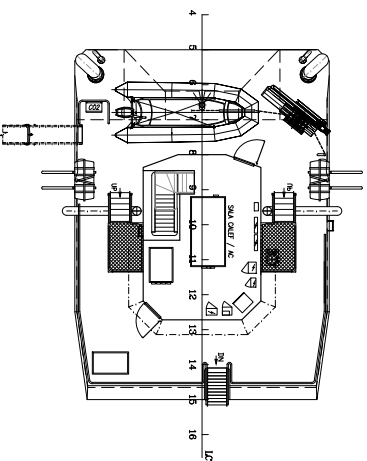

CUBIERTA DE ACOMODACIONES

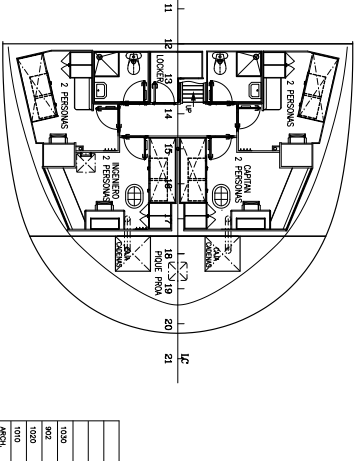
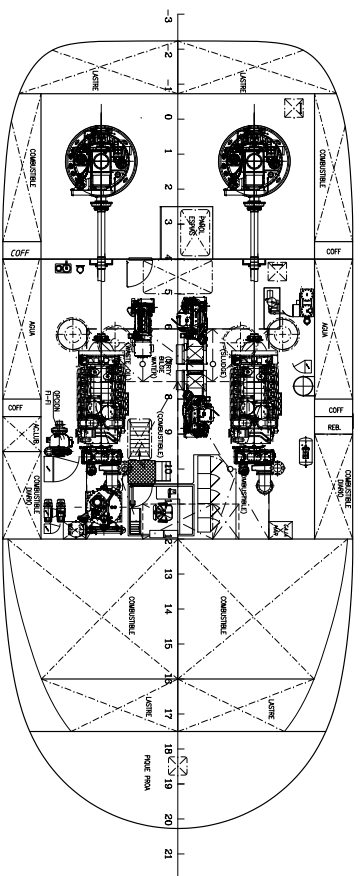

**REMOLOCADOR 25m
70 TON BOLLARD PULL**

CARACTERISTICAS PRINCIPALES

ESLORA TOTAL	25,80 m.
ESLORA CASCO	24,70 m.
MANA WOLDEDO	11,00 m.
CUNTA WOLDEDO	4,80 m.
CUNTA WAKIMO (S.L.S.)	2,80 m.
POTENCIA	200 HP o 150 KW o 1800 RPM
BOLLARD PULL	70 TON.
F-F-I-I	2 x 1200 m ³ /hr
TRIPULACION	8 PERS.

7	SE. ANKORA P-F-I	2000/2000	K.C.						
C	RELOCADOR SISTEMA PROPULSION	04/06/2001	K.C.						
8	Propulsor								
9	Mano								
10	Mano								
11	Mano								
12	Mano								
13	Mano								
14	Mano								
15	Mano								
16	Mano								
17	Mano								
18	Mano								
19	Mano								
20	Mano								
21	Mano								
22	Mano								
23	Mano								
24	Mano								
25	Mano								
26	Mano								
27	Mano								
28	Mano								
29	Mano								
30	Mano								
31	Mano								
32	Mano								
33	Mano								
34	Mano								
35	Mano								
36	Mano								
37	Mano								
38	Mano								
39	Mano								
40	Mano								
41	Mano								
42	Mano								
43	Mano								
44	Mano								
45	Mano								
46	Mano								
47	Mano								
48	Mano								
49	Mano								
50	Mano								
51	Mano								
52	Mano								
53	Mano								
54	Mano								
55	Mano								
56	Mano								
57	Mano								
58	Mano								
59	Mano								
60	Mano								
61	Mano								
62	Mano								
63	Mano								
64	Mano								
65	Mano								
66	Mano								
67	Mano								
68	Mano								
69	Mano								
70	Mano								
71	Mano								
72	Mano								
73	Mano								
74	Mano								
75	Mano								
76	Mano								
77	Mano								
78	Mano								
79	Mano								
80	Mano								
81	Mano								
82	Mano								
83	Mano								
84	Mano								
85	Mano								
86	Mano								
87	Mano								
88	Mano								
89	Mano								
90	Mano								
91	Mano								
92	Mano								
93	Mano								
94	Mano								
95	Mano								
96	Mano								
97	Mano								
98	Mano								
99	Mano								
100	Mano								
101	Mano								
102	Mano								
103	Mano								
104	Mano								
105	Mano								
106	Mano								
107	Mano								
108	Mano								
109	Mano								
110	Mano								
111	Mano								
112	Mano								
113	Mano								
114	Mano								
115	Mano								
116	Mano								
117	Mano								
118	Mano								
119	Mano								
120	Mano								
121	Mano								
122	Mano								
123	Mano								
124	Mano								
125	Mano								
126	Mano								
127	Mano								
128	Mano								
129	Mano								
130	Mano								
131	Mano								
132	Mano								
133	Mano								
134	Mano								
135	Mano								
136	Mano								
137	Mano								
138	Mano								
139	Mano								
140	Mano								
141	Mano								
142	Mano								
143	Mano								
144	Mano								
145	Mano								
146	Mano								
147	Mano								
148	Mano								
149	Mano								
150	Mano								
151	Mano								
152	Mano								
153	Mano								
154	Mano								
155	Mano								
156	Mano								
157	Mano								
158	Mano								
159	Mano								
160	Mano								
161	Mano								
162	Mano								
163	Mano								
164	Mano								
165	Mano								
166	Mano								
167	Mano								
168	Mano								
169	Mano								
170	Mano								
171	Mano								
172	Mano								
173	Mano								
174	Mano								
175	Mano								
176	Mano								
177	Mano								
178	Mano								
179									